

KLINGPAK

KP-GR1 Pneumatic Carton Stapler

MANUAL/WARNING:

IMPORTANT PLEASE READ BEFORE USING TOOL

Please read the following operating instructions manual. Refer to this manual for safety, adjustment and trouble shooting instructions. If you have any further questions please contact your distributor.



1320 Tower Road Schaumburg, IL 60173
Phone: 888-392-9947 Fax: 877-393-2948



TABLE OF CONTENTS

	PAGE
TOOL SPECIFICATIONS	4
SAFETY INSTRUCTIONS	5
LUBRICATION AND MAINTENANCE	6
ADJUSTING FOR STAPLE LEG LENGTH	6
CLINCH ADJUSTMENT	7
DEPTH ADJUSTMENT	7
EXPLODED VIEW OF TOOL.....	8
PARTS LIST.....	9
TROUBLE SHOOTING	10



TOOL SPECIFICATIONS

MODEL OF TOOLKP-GRPN
DIMENSIONS (LENGTH x HEIGHT x WIDTH) 9.5" x 4.5" x 9"
WEIGHT (WITHOUT FASTENERS) 5.3 lbs

COMPRESSED AIR :

MAXIMUM PERMISSIBLE OPERATING PRESSURE 90 PSI
RECOMMENDED OPERATING PRESSURE..... 71 PSI
AIR CONSUMPTION 0.067 M³ / MIN (2.4 C.F.M)
WITH 60 STAPLES PER MINUTE
@5.66 KG/CM²(80 PSI)
STAPLE SPECIFICATION 1-1/4" CROWN (GR series),
LEG LENGTH 5/8", 3/4"
STAPLE CAPACITY 1000 PCS (1, 1M Roll)

THE NOISE LEVELS: (AT THE WORKPLACE, ALWAYS WEAR HEARING PROTECTION EQUIPMENT.)

A WEIGHTED SINGLE EVENT SOUND PRESSURE LEVEL AT OPERATOR'S POSITION: **L Pa, 1s = 89 dBA**

A WEIGHTED SINGLE EVENT SOUND POWER LEVEL **L WA, 1s = 93 Dba**

A WEIGHTED SINGLE EVENT SURFACE SOUND PRESSURE LEVEL **L Pa, 1s, 1m = 80 dBA**

KLINGH-PAK

SAFETY INSTRUCTIONS



- Read this manual and understand all safety instructions before operation of the tool. If you have any questions, please contact our Authorized Representatives.



- **Never** allow use of any type of Flammable Gases or Oxygen as a power source for the tool. Use only Filtered, Lubricated, Regulated, Compressed Air.



- **Never** use Gasoline or other Flammable Liquids to clean the tool. Vapors in the tool will ignite by a spark and cause it to explode.



- **Do not exceed** Maximum Permissible Operating Pressure of the tool (90-PSI).



- Disconnect the tool from air supply before clearing jams, servicing, adjusting and during non-operation.



- **Do not** carry the tool by the hose or pull the hose to move the tool.



- Always wear protective equipment such as safety glasses, ear protection and head protection.

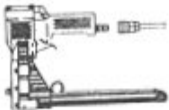

- **Do not** remove the check valve or any other fitting which allows air to remain in the tool.



- **Do not** place your hand or any part of your body in the staple clinching area or adjustment window when connecting or disconnecting the air supply.



- **Never** point any tools that fire projectiles at yourself or another person.

KLINGH-PAK

LUBRICATION AND MAINTENANCE



- Your tool requires lubrication before you use for the **First Time**.

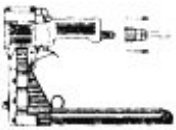

- Disconnect the Air Supply** from the tool before lubricating



- Turn the tool so the inlet is facing up and put one drop of Lubricating Oil into air inlet. **NEVER** use **DETERGENT OIL** or **ADDITIVES**. Operate the tools briefly after adding oil.

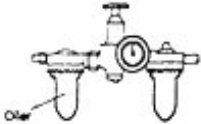

- Wipe off excess oil at the exhaust. Excess oil will damage the O-Rings of the tool (If in-line oiler is used). Manual lubrication through the air inlet is **NOT** required on a daily basis.

ADJUSTING FOR STAPLE LEG LENGTH



- Disconnect the Air Supply**



- Loosen the set screw (526 on Schematic) with a 3 mm Hex Key
- Turn adjusting rod (018 on Schematic) 180 degrees with a flat head screw drive to the desired setting. See diagram A, for positioning explanation.

A.

STAPLES LENGTHS	15MM	18MM
ROD POSITION		

- Tighten Set Screw (526) when positioned to desired setting.

KLING-PAK

CLINCH ADJUSTMENT



- **Disconnect the Air Supply**
- Use 3mm Rod or 2.5mm Hex Key to turn the collar (006 on Schematic) found in the front window of the tool. Rotate clockwise for tighter clinch. Counterclockwise for the loose setting. See diagram B.

B.

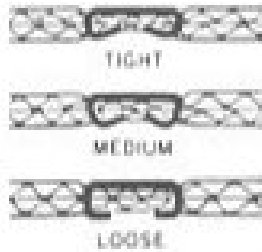

DEPTH ADJUSTMENT



- **Disconnect the Air Supply**
- Loosen the Front Screw (527 on the Schematic) with a 6 mm Hex Key.

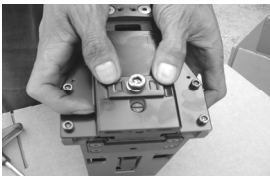

- Push the body (007) up and adjust to desired depth.



- When top edge of the adjustment plate (019) is at it's highest setting the teeth are at their shallowest penetration. If set at lowest position, the teeth are at their deepest penetration. See diagram C.

C.

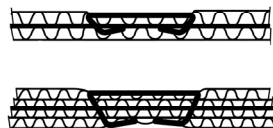

MODEL : KP-CR1

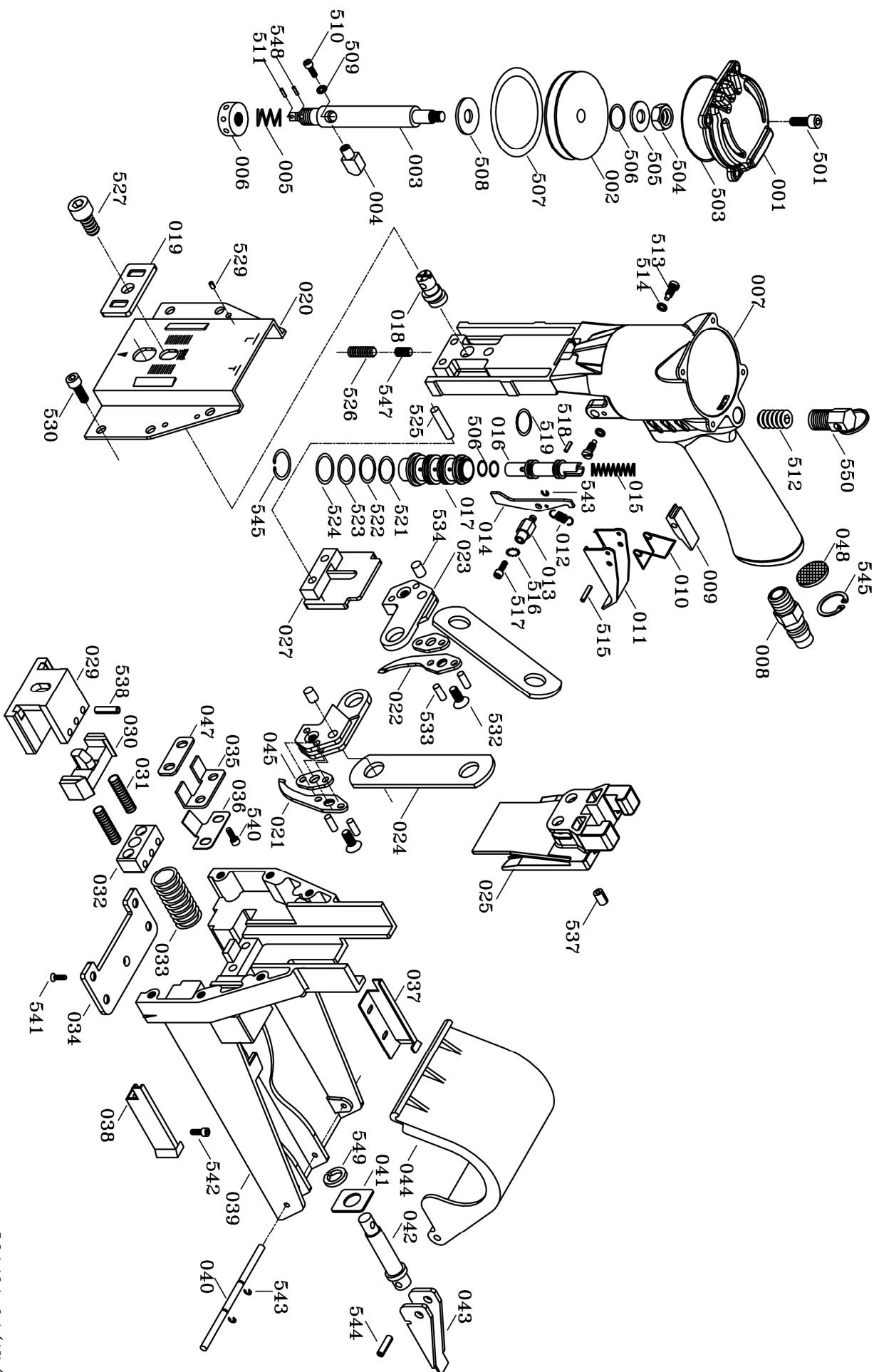

PARTS LIST (KP-GR1)

*WHEN ORDERING SPARE PARTS, PLEASE STATE ITEM No.,PART NO. AND DESCRIPTION.

ITEM	PART NO	DESCRIPTION	QTY	ITEM	PART NO	DESCRIPTION	QTY	ITEM	PART NO	DESCRIPTION	QTY
001	91000102	CAP	1	037	91303801	RIGHT COIL GUIDE	1	526	91006601	HEX.SOC.HDLESS.BOLT	1
002	91000201	PISTON	1	038	91303901	LEFT COIL GUIDE	1	527	91006701	HEX.SOC.HD.BOLT	1
003	91000301	PISTON ROD	1	039	91406001	MAGAZINE SEAT	1	528	91307501	SPRING PIN	2
004	91000401	BLOCK	1	040	91304201	SHAFT	1	529	91006801	SPRING PIN	4
005	91000501	SPRING	1	041	91404301	WASHER	1	530	91307001	HEX.SOC.HD.BOLT	6
006	91000601	COLLAR	1	042	91304501	SHAFT	1	531	91008001	LOCK NUT	1
007	91000701	BODY	1	043	91304601	LEVER	1	532	91307101	FLAT HD.BOLT	2
008	91000801	AIR PLUG	1	044	91304701	COVER	1	533	91007201	PIN	4
009	91001101	BLOCK	1	045	91304801	PLATE	2	534	91007301	PIN	2
010	91001201	SPRING	1	047	91305201	WASHER	2	537	91007501	SPRING PIN	2
011	91001301	TRIGGER	1	048	91004301	STENCER	1	538	91307601	SPRING PIN	3
012	91001401	SPRING	1	501	91004201	HEX.SOC.HD.BOLT	4	540	91307201	HEX.SOC.FLAT COUNTER SMK	1
013	91001501	ROD	1	503	91004401	O-RING	1	541	91307801	HEX.SOC.FLAT	4
014	91001601	TRIGGER'S CONTROL	1	504	91004501	HEX.NUT	1	542	91307901	ROUND.HD.SCREW	4
015	91001701	SPRING	1	505	91004601	WASHER	1	543	91008401	E-RING	3
016	91001801	VALVE	1	506	91004701	O-RING	3	544	91308001	SPRING PIN	1
017	91001901	TUBE	1	507	91004801	O-RING	1	545	91008301	C-RING	2
018	91002001	ADJUSTING ROD	1	508	91004901	WASHER	1	547	91008701	HELI-COIL	1
019	91002101	ADJUSTING PLATE	1	509	91005001	SPRING WASHER	1	548	91008801	PLASTIC PIN	1
020	91302201	FRONT PLATE	1	510	91005101	HEX.SOC.HD.BOLT	1	549	91308101	WAVE WASHER	1
021	91002301	RIGHT TEETH	1	511	91005201	SPRING PIN	1	550	91008901	COUNTER BALANCE	1
022	91002401	LEFT TEETH	1	512	91005301	HEX.SOC.HDLESS.BOLT	1				
023	91002501	TEETH SEAT	2	513	91005401	TRIGGER SCREW	2				
024	91002601	PLATE	2	514	91005501	SPRING WASHER	2				
025	91402801	DRIVER	1	515	91005601	SPRING PIN	1				
027	91402901	DRIVER GUIDE UNIT	1	516	91005701	OUTSIDE TEETH WASHER	1				
029	91303001	ANVIL	1	517	91005801	HEX.SOC.HD.BOLT	1				
030	91403101	PUSHER	1	518	91005901	SPRING PIN	1				
031	91303201	SPRING	2	519	91006001	O-RING	1				
032	91303301	ANVIL CAP	1	521	91006101	O-RING	1				
033	91303401	SPRING	1	522	91006201	O-RING	1				
034	91303501	PLATE	1	523	91006301	O-RING	1				
035	91305001	TOP GUIDE	1	524	91006401	O-RING	1				
036	91305101	LEAF SPRING	1	525	91006501	ROD	2				

NO : L91411

DATE:06/27/2008



TROUBLE SHOOTING

PROBLEM	CAUSE	REMEDY
AIR LEAKAGE FROM TRIGGER .	O-RING ON VALVE (016) OR ON TUBE (017) ARE DAMAGED .	O-RING MUST BE REPLACED
AIR LEAKAGE FROM EXHAUST PORT .	O-RINGSON VALVE (016) OR ON TUBE (017) ARE DAMAGED .	O-RING MUST BE REPLACED
	PISTON'S O-RING (507) IS DAMAGED .	O-RING MUST BE REPLACED
AIR LEAKAGE RROM CYLINDER (004) .	PISTON ROD PORT (007) O-RING (519) IS DAMAGED .	REPLACE THE O-RING .
SLOW AND SHORT TRAVEL CYCLING	CHECK FOR LOOSED SCREW (517) AND WEAR OF PARTS (014,009)	POSITION ECCENTRIC PIN (013) AS SHOWN AND TIGHTEN SCREW (517). IF SHORT TRAVEL OCCURS ADJUST PIN POSITION IN AN UPWARD POSITION. IF SLOW CYCLE ADJUST PIN IN A DOWNWARD DIRECTION.
EXCESSIVE JAMS :	SLOW AND SHORT TRAVEL CYCLING .	CHECK AS NOTED IN SLOW AND SHORT TRAVEL CYCLING SECTION .
	ANVIL SCREWS LOOSE .	TIGHTEN SCREWS
	STAPLE SIZE IS WRONG .	USE THE PROPER SIZE STAPLE
	INSUFFICIENT LUBRICATION	SUITABLY CLEAN AND LUBRICATE
UNEVEN CLINCH	WRONG STAPLE SIZE	CHECK FOR PROPER LEG LENGTH ADJUSTMENT & CLINCHER SIZE .
UNCLINCHED STAPLE	ANVIL (021,022) LOOSE	TIGHTEN ANVIL (021,022)
	ANVIL (021,022) ARE BROKEN	REPLACE ANVIL (021,022)
	SLOW AND SHORT TRAVEL CYCLING .	CHECK AS NOTED IN SLOW AND SHORT TRAVEL CYCLING SECTION .

Products offered by



KLING-PAK

COMPLETE

APACH

Rapid ®

Call today for more details

Visit our web site
www.axxisus.com

Or

Email us @
reception.inc@axxisus.com



1320 Tower Road Schaumburg, IL 60173
Phone: 888-392-9947 Fax: 877-393-2948