

# operating instruction

**a.560PN**  
#125101

DE, EN, FR, SE



BRINGING TOGETHER  **JOSEF KIHMBERG**

# Table of Contents

---

Installation .....	3
Tool use .....	4-5
Safety precautions.....	6-7
Troubleshooting and maintenance .....	8
Technical specification.....	9
Spare parts drawing .....	10-11
Spare parts kits, accessories.....	12
Applications .....	13
Warranty terms, serial numbers .....	14
CE Conformity Declaration.....	15

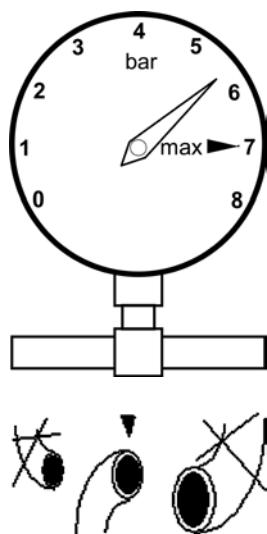

## Installation

Adjust to the lowest air pressure that will bend the staples correctly. Start at about 5.0 bar and increase the pressure by 0.5 bar increments until the pressure is correct.

**Never exceed 8 bar.**

Low air pressure helps to keep down maintenance costs.

Make sure that the minimum internal diameter of the air hose is 6 mm (1/4") and that of the nipple is a minimum of 5 mm (6/32"). This will prevent incorrect operation due to a significant drop in pressure. The tool and the hose must be fitted with a connection nipple that automatically bleeds the tool when it is disconnected.

# Tool use

Adjust to the lowest air pressure that will bend the staples correctly. Start at about 5.0 bar and increase the pressure by 0.5 bar increments until the pressure is correct. Never exceed 8 bar.

Low air pressure helps to keep down maintenance costs.

The tool is adjustable for 15 or 18 mm staples. The tool setting for a different staple leg length is altered as follows. Start by adjusting the depth of stapling for deep clinching (=) as shown in the upper picture.

Then in order to adjust to required leg length.

1. Slacken the locking screw (A) underneath with a 2.5 mm Allen key.
2. Set to the required staple leg length.
3. Tighten the locking screw.

The depth of the stapling claws is easily adjusted using the setting knob. Depress the knob and turn it to the required position.

- Shallow stapling
- = Deep stapling

It is possible to adjust how tightly the staple is closed. Turn the adjusting nut clockwise (A) to close the staple tightly and anticlockwise (B) to close it less tightly.

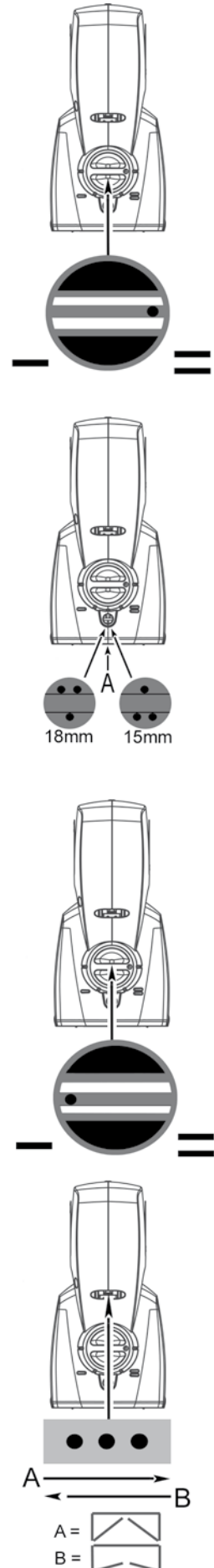

## Tool use

Only use original JK560 staples (15 or 18 mm leg length).

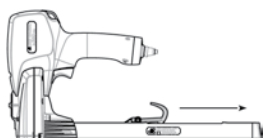
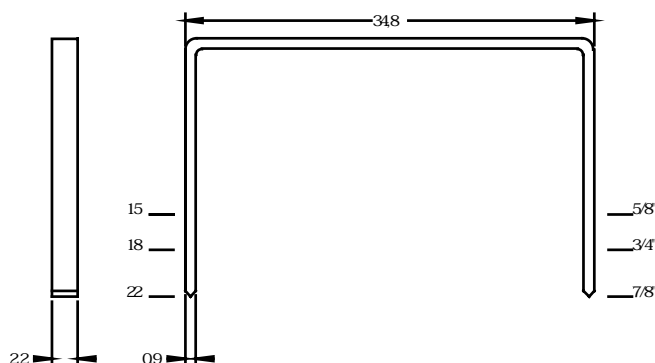

Load the magazine as follows:

1. Hold the pusher by its finger grip and pull the pusher back until it latches in the magazine.

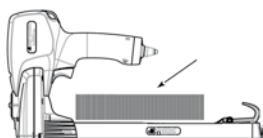

2. Insert two sticks of staples into the magazine.

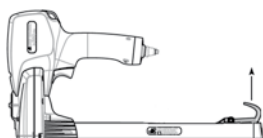

3. Lift the finger grip up to release the latch. Move the pusher forward until it is touching the rearmost staple stick.

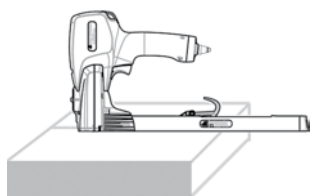

Stapling cardboard:

4. Hold the tool against the cardboard (A). Then pull the trigger (B). The tool automatically returns to the first position. Then move the tool and pull the trigger to fire the next staple.

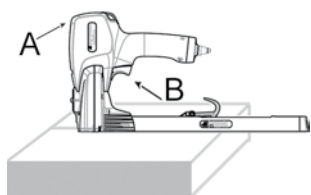

# Safety precautions

---

The employer is responsible for ensuring that:

- these Operating Instructions and appended documents are made available to all personnel concerned, and that they read, understand and comply with the instructions;
- the personnel operating the tool are sufficiently trained and are well aware of the risks of accident, appropriate working methods and tool maintenance;
- general safety regulations, and specific regulations with respect to minors working with nail guns/stapler tools, are complied with;
- personnel are given the instructions, equipment and time to perform daily tool inspection.

Please read these safety precautions carefully to prevent injury to yourself and others. Refer to the later sections for additional information.

To prevent eye injuries, the operator and others in the work area should wear eye protection.

Ear protection and other personal protection equipment should also be worn as required.

Never use oxygen, combustible gases, CO<sub>2</sub>, steam or high pressure gas tanks as power sources for the PN (pneumatic) version of this tool as these may cause the tool to explode and cause serious injury. Only use dry, clean, regulated compressed air to power the tool.

Never use a defective tool. Inspect the tool every day to ensure that the trigger is working properly and that all screws and nuts are secured tightly.





## Safety precautions

---

It is not permissible to make changes or modifications to this tool or set it up in a jig without the manufacturer's approval.

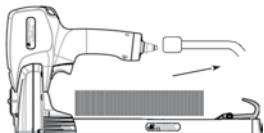

Always disconnect the tool from the air supply and empty the magazine when you leave the tool for breaks, at the end of the day, when troubleshooting, or when carrying out maintenance or repairs. Never leave a loaded tool unattended.

Always assume that the tool is loaded. This is a working implement and not a toy. Never point the tool at yourself or anyone else, whether it contains staples or not. Always remove your finger from the trigger when not driving staples.

Avoid personal injury. Never hold your hand or any other part of your body under the tool. Always place yourself in a firmly balanced position when using the tool.

Connect the tool to the compressed air system before the fastener unit is loaded. The maximum permitted air pressure for the tool is 8 bar (116 psi). The maximum supply pressure is 8.8 bar (127 psi). Make sure that the minimum internal diameter of the air hose is 6 mm (1/4") and that of the nipple is a minimum of 5 mm (6/32"). This will prevent incorrect operation due to a significant drop in pressure. The tool and the hose must be fitted with a connection nipple that automatically bleeds the tool when it is disconnected.

## Troubleshooting

Always disconnect the tool from the air supply, empty the magazine and read the **Safety precautions** section before you begin troubleshooting. Normally it is not necessary to dismantle any parts in order to remove a defective staple from the front nozzle plate. Grip the staple with a pair of flat-nosed pliers at the exit from the front nozzle plate. Carefully pull out the staple.

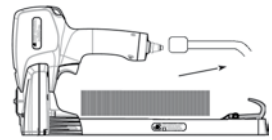

## Maintenance

All safety devices must be inspected daily to ensure that they are working properly. Make especially sure that:

- the trigger and safety yoke move freely without binding;
- all screws and nuts are securely tightened.

This tool does not require special servicing. It only needs regular cleaning with a non-aggressive cleaning agent. Do not remove any parts for cleaning purposes.

Apply a small amount of lubricating oil to the nipple of the tool every day or approximately 10 drops once a week to maximize the life and utility of the tool. For high-frequency stapling, we recommend oil-mist lubrication. Please contact our agent for advice. Oil recommendation.

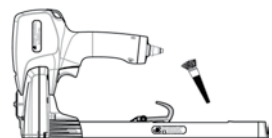
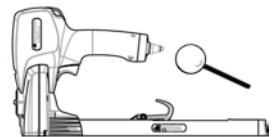

Part no.:

1 litre	184314
0.2 litre	733007

Sliding parts have been lubricated with multipurpose grease at the factory. We recommend using multipurpose grease on moving parts after they have been cleaned or replaced.





## Technical specification

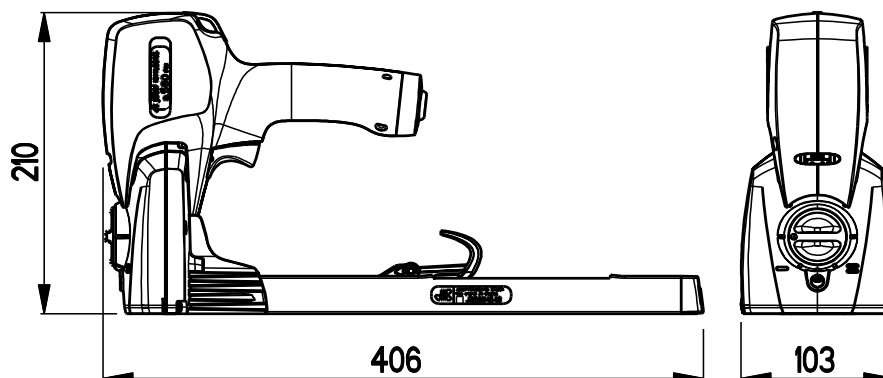

- The maximum permitted air pressure for the tool is 8 bar (116 psi). The maximum supply pressure is 8.8 bar (127 psi).
- Air consumption per driving operation: 0.95 l at 6 bar operating pressure.
- Characteristic noise emission level as per EN 12549.
- A-weighted single-event emission sound pressure level at work station: LPA, 1s = **84dB**
- A-weighted sound energy level: LJA = **89dB**
- The vibration level is below the limit as stated in the Declaration of Conformity EN 792-13 measured according to ISO 8662-11.

# Spare parts drawing

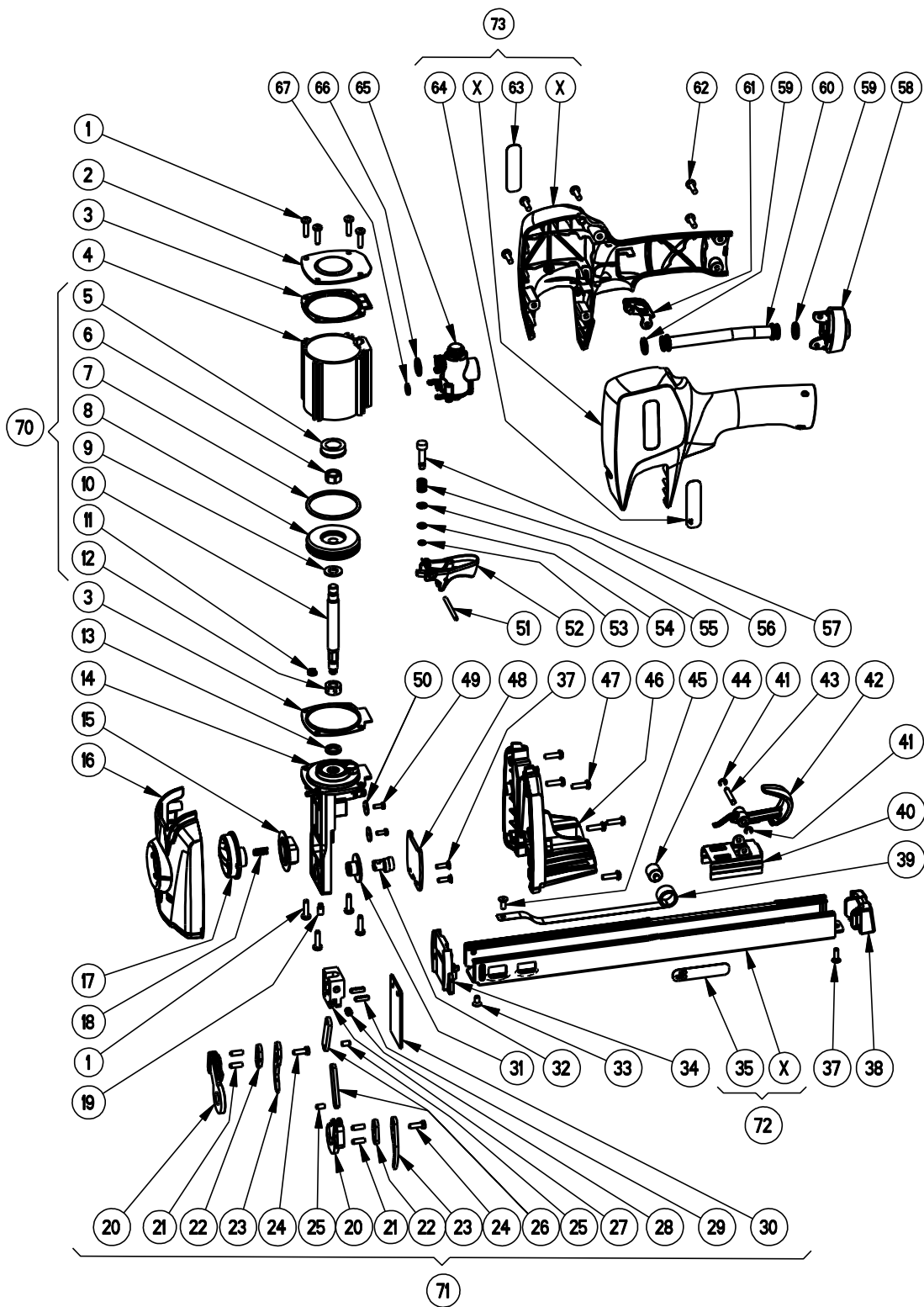

To achieve optimal performance and safety, only use original spare parts. All repairs must be carried out by an authorised JK workshop.

Ref	Part	Qty	Description
	143109		O-ring kit a,c,R PN
	143110		Repair kit a560PN
1	946760	8	Screw
2	190204	1	Top cap
3	148064	2	Gasket
4	190203	1	Cylinder
5	149057	1	Piston stop
6	946004	1	Nut
7	972115	1	O-ring
8	191204	1	Piston a560 c561PN
9	947015	1	Washer
10	191205	1	Piston a,c,R
11	950006	1	Fix ring
12	146245	1	Clinch adjustment nut
13	972142	1	O-ring
14	139525	1	Casting
15	150421	1	Cage
16	139542	1	Front Section
17	165124	1	Penetration control knob
18	173155	1	Spring
19	946651	1	Screw
20	176417	2	Anvil holder
21	945096	4	Pin
22	147127	2	Spacer
23	158316	2	Anvil hook 15-18mm
24	946687	2	Screw
25	945115	2	Pin
26	163322	2	Link
27	161355	1	Connecting yoke
28	960020	1	Latch
29	145171	2	Pin
30	164295	1	Driver blade a560
31	150420	1	Bushing
32	163321	1	Penetration eccentric
33	946696	1	Screw
34	162991	1	Rear nozzle plate a560
35	110306	1	Lable magazines
37	946769	3	Screw
38	170174	1	Magazine lid a560, c561
39	174074	1	Feeder spring
40	161354	1	Pusher a560 c561
41	951020	2	Retainer
42	165122	1	Finger grip
43	145166	1	Shaft
44	150414	1	Roller
45	946518	1	Screw
46	155157	1	Rear body
47	946780	11	Screw
48	162993	1	Front nozzle plate
49	946761	2	Screw
50	947062	2	Washer
51	945116	1	Pin
52	133179	1	Trigger compl
53	972084	1	O-ring
54	972077	1	O-ring
55	147128	1	Washer
56	173185	1	Spring
57	191206	1	Stem
58	179114	1	Rear cap
59	972176	2	O-ring
60	187062	1	Tube
61	176424	1	Hanger
62	946780	11	Screw
63	110313	1	CE Lable
64	110303	1	Tool lable
65	136169	1	Valve a,c,R
66	972030	1	O-ring
67	972020	1	O-ring
70	134307	1	Piston cpl a560, c561PN
71	134308	1	Clinch unit compl. a560PN
72	132796	1	Rail assembly
73	139526	1	Handle cpl

## Spare parts kits

143109 O-ring kit

143110 Repair kit

## Accessories

142000 Staple remover

142136 Packing staple remover

733007 Oil-mist lubrication 0.2 litre dosage spout

184943 JK silicon compound



142000



142136



733007



184943



# Applications

---

Optimising your stapling:

Packaging programme:

[www.carton-closing.com/packaging](http://www.carton-closing.com/packaging)

Stapling handbook:

[www.staplinghandbook.com](http://www.staplinghandbook.com)

## Warranty terms

---

Josef Kihlberg warrants that the tools are in good working order on delivery and for a period of 12 months thereafter, on condition that the purchase was from Josef Kihlberg or an authorised Josef Kihlberg distributor.

The warranty covers faulty material and manufacturing. Moving and wearing parts such as pistons, drive units and feed components are not included in the Josef Kihlberg warranty if exchange is required due to wear. The warranty is rendered invalid if the tool is modified or altered in any way by any party other than Josef Kihlberg.

The vendor may choose whether to repair or exchange the tool. Exchanged components or complete Josef Kihlberg tools become the property of the vendor as a result of the exchange. The warranty does not cover damage caused by accidents, incorrect installation or improper use.

The warranty does not cover any incidental or consequential costs or damages resulting from failure to follow the operating instructions. Josef Kihlberg cannot be held financially responsible for losses suffered by the customer, including loss of savings or revenue, damages or pecuniary losses.

## Serial numbers

---

Construction, example: 0713001

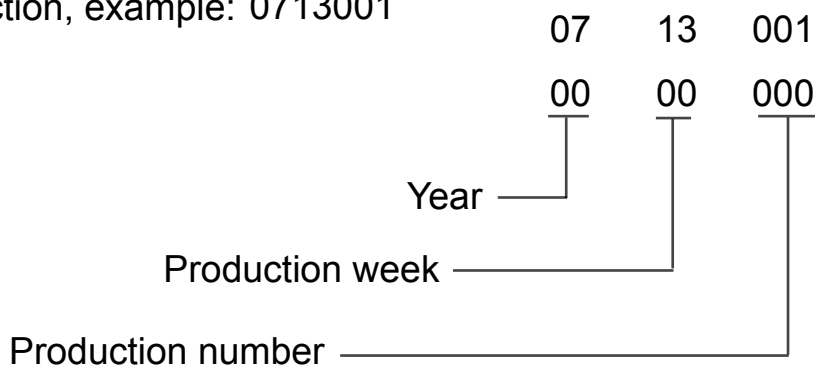

# CE Conformity Declaration

**CE** EU DECLARATION OF CONFORMITY  
In compliance with the  
Machinery Directive 98/37/EC

Company:  
Josef Kihlberg  
Box 126  
544 22 HJO  
SWEDEN

hereby declares that all versions of the following kinds of tools

a.560PN, a.560PN22, c.561PN, c.561PN22

have been manufactured in compliance with the following  
harmonised standards:

EN ISO 12100 parts 1+2  
EN 792-13

And in compliance with the European Council Directives  
98/37/EC.

Hjo 20 Sept. 2006



Jonas Zachrisson  
Head of Development